

Location of controls and basic operations

Main unit

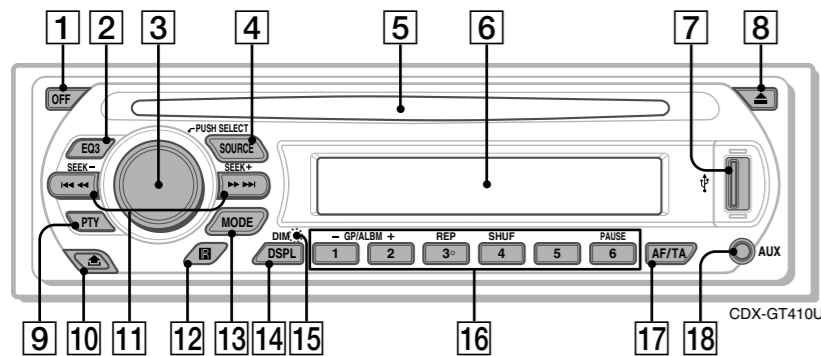

Card remote commander RM-X151

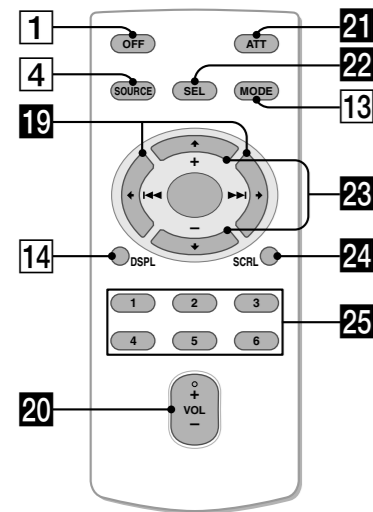

Before using the card remote commander for the first time, remove the insulation film.



- 1 **OFF button**
To power off; stop the source.
- 2 **EQ3 (equalizer) button**
To select an equalizer type (XPLOD, VOCAL, EDGE, CRUISE, SPACE, GRAVITY, CUSTOM or OFF). To adjust the equalizer curve, see "Customizing the equalizer curve" on the reverse side of this sheet.
- 3 **Volume control dial/select button**
To adjust volume (rotate); select setup items (press and rotate).
- 4 **SOURCE button**
To power on; change the source (Radio/CD/MD*1/USB/AUX).

- 5 **Disc slot**
Insert the disc (label side up), and playback starts automatically. You can play CD-DA (also containing CD TEXT), CD-R/CD-RW (MP3/WMA/AAC files also containing Multi Session) and ATRAC CD (ATRAC3 and ATRAC3plus format).
- 6 **Display window**
- 7 **USB terminal**
To connect to the USB device.
- 8 **(eject) button**
To eject the disc.
- 9 **PTY (Program Type) button**
To select PTY in RDS. After pressing (PTY), press (SEEK) +/- to search for a station.

- 10 **(front panel release) button**
- 11 **SEEK +/- buttons**
CD/MD*1/USB*2:
To skip tracks (press); skip tracks continuously (press, then press again within about 1 second and hold); reverse/fast-forward a track (press and hold).
Radio:
To tune in stations automatically (press); find a station manually (press and hold).
- 12 **Receptor for the card remote commander**
- 13 **MODE button**
To select the radio band (FM/MW/LW); select the unit*3; select the play mode*4.
- 14 **DSPL (display)/DIM (dimmer) button**
To change display items (press); change the display brightness (press and hold).
- 15 **RESET button** (located behind the front panel)
Detach the front panel and press the RESET button with a pointed object, such as a ball-point pen.

- 16 **Number buttons**
CD/MD*1/USB*2:
①/②: GP*5/ALBM*6 +/-
To skip groups/albums (press); skip groups/albums continuously (press and hold)*7.
③: REP
④: SHUF
⑥: PAUSE*8
Radio:
To receive stored stations (press); store stations (press and hold).
- 17 **AF/TA button**
AF (Alternative Frequencies)/TA (Traffic Announcement), TP (Traffic Programme):
Each time you press (AF/TA), the item changes as follows:
AF-ON → TA-ON → AF, TA-ON → AF, TA-OFF
- 18 **AUX input jack**
To connect a portable audio device.

- 19 **(Left/Right) buttons**
To control CD/radio/MD/USB, the same as (SEEK) +/- on the unit.
- 20 **VOL (volume) +/- button**
To adjust volume.
- 21 **ATT (attenuate) button**
To attenuate the sound. To cancel, press again.
- 22 **SEL (select) button**
The same as the select button on the unit.

- 23 **(+/-) buttons**
To control CD, the same as ①/② (GP/ALBM +/-) on the unit.
- 24 **SCRL (scroll) button**
To scroll the display item.
- 25 **Number buttons**
To receive stored stations (press); store stations (press and hold).

- *1 When an MD changer is connected.
- *2 When a USB device is connected.
- *3 When a CD/MD changer is connected.
- *4 When an ATRAC Audio Device is connected.
- *5 When an ATRAC CD is played.
- *6 When an MP3/WMA/AAC is played.
- *7 If the changer/USB device is connected, the operation is different.
- *8 When playing back on this unit.

- Notes**
• Before operating the unit for the first time, or after replacing the car battery or changing the connections, you must reset the unit.
• Pressing the RESET button will erase the clock setting and some stored contents.

- The following buttons on the card remote commander have also different buttons/functions from the unit.
- 21 **ATT (attenuate) button**
To attenuate the sound. To cancel, press again.
- 22 **SEL (select) button**
The same as the select button on the unit.

Detaching the front panel

You can detach the front panel of this unit to prevent theft.

- 1 Press (OFF).
The unit is turned off.
- 2 Press (front panel release) button, then pull it off towards you.

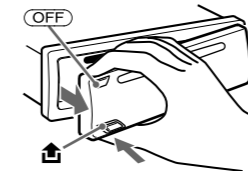

Attaching the front panel

Engage part (A) of the front panel with part (B) of the unit, as illustrated, and push the left side into position until it clicks.

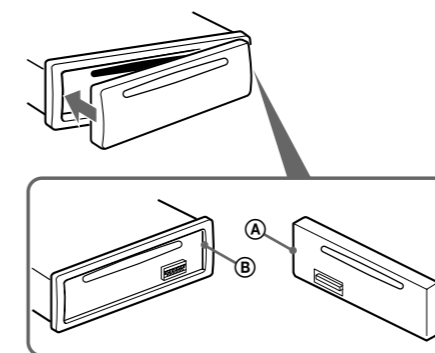

Warning if your car's ignition has no ACC position
Be sure to set the Auto Off function. The unit will shut off completely and automatically in the set time after the unit is turned off, which prevents battery drain. If you do not set the Auto Off function, press and hold (OFF) until the display disappears each time you turn the ignition off.

SET UP

Setting the clock

The clock uses a 24-hour digital indication.

- 1 Press and hold the select button.
The setup display appears.
- 2 Press the select button repeatedly until "CLOCK-ADJ" appears.
- 3 Press (SEEK) +.
The hour indication flashes.
- 4 Rotate the volume control dial to set the hour and minute.
To move the digital indication, press (SEEK) +/-.
- 5 Press the select button.
The setup is complete and the clock starts.

Tip
You can set the clock automatically with the RDS feature. For details, see "Adjusting setup items" on the reverse side of the sheet, and set to "CT-ON" (Clock Time).

RADIO

Storing stations automatically

— BTM

The unit selects strong signal stations and stores them. You can store up to 6 stations per band (FM1, FM2, FM3, MW, or LW).

Caution
When tuning in stations while driving, use Best Tuning Memory (BTM) to prevent an accident.

- 1 Press (SOURCE) repeatedly until "TUNER" appears.
To change the band, press (MODE) repeatedly. You can select from FM1, FM2, FM3, MW or LW.
- 2 Press and hold the select button.
The setup display appears.
- 3 Press the select button repeatedly until "BTM" appears.
- 4 Press (SEEK) +.
The unit stores stations in order of frequency on the number buttons.
A beep sounds when the setting is stored.

CD

Display items for CD

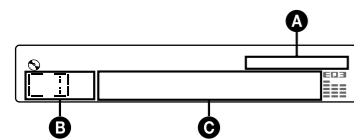

- A** AAC/WMA/ATRAC/MP3 indication
- B** Source
- C** Track number/Elapsed playing time, Disc/artist name, Album/group number*, Album/group name, Track name, Text information, Clock

* Album/group number is displayed only when the album/group is changed.

To change display items **C**, press **(DSPL)**; scroll display items **C**, press **(SCRL)** on the card remote commander or set "A.SCRL-ON."

CD

Repeat and shuffle play

- 1** During playback, press **(3)** (REP) or **(4)** (SHUF) repeatedly until the desired setting appears.

Select	To play
↵ TRACK	track repeatedly.
↵ ALBUM*1	album repeatedly.
↵ GROUP*2	group repeatedly.
SHUF ALBUM*1	album in random order.
SHUF GROUP*2	group in random order.
SHUF DISC	disc in random order.

*1 When an MP3/WMA/AAC is played.
 *2 When an ATRAC CD is played.

To return to normal play mode, select "**↵ OFF**" or "SHUF OFF."

USB

Playback USB devices

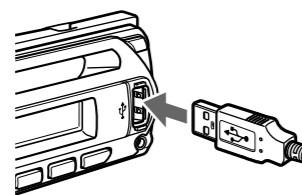

- 1** Connect the USB device to the USB terminal. Playback starts.

Press **(OFF)** to stop playback.

Note
 Before removing a USB device, be sure to stop playback first. If you remove your USB device during playback, data in the USB device may be damaged.

USB

Display items for USB

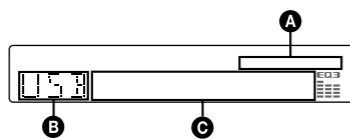

- A** AAC/WMA/ATRAC/MP3 indication
- B** "Walkman" (ATRAC Audio Device): ALB, ART, PLY Mass Storage Class: USB
- C** Track/Album/Artist/Playlist number, Track/Album/Artist/Playlist name, Elapsed playing time, Clock

Note
 The display differs depending on the Mass Storage Class type USB device, and "Walkman" (ATRAC Audio Device).

USB

Listening to music on a Mass Storage Class type audio device

Repeat and shuffle play

- 1** During playback, press **(3)** (REP) or **(4)** (SHUF) repeatedly until the desired setting appears.

Select	To play
↵ TRACK	track repeatedly.
↵ ALBUM	album repeatedly.
SHUF ALBUM	album in random order.
SHUF DEVICE	device in random order.

To return to normal play mode, select "**↵ OFF**" or "SHUF OFF."

USB

Listening to music on "Walkman" (ATRAC Audio Device)

- 1** During playback, press **(MODE)** repeatedly until the desired setting appears.

The item changes as follows:
ALB (Album) → **ART** (Artist) → **PLY** (Playlist)

Repeat and shuffle play

- 1** During playback, press **(3)** (REP) or **(4)** (SHUF) repeatedly until the desired setting appears.

Select	To play
↵ TRACK	track repeatedly.
↵ ALBUM	album repeatedly.
↵ ARTIST	artist repeatedly.
↵ PLAYLIST	playlist repeatedly.
SHUF ALBUM	album in random order.
SHUF ARTIST	artist in random order.
SHUF PLAYLIST	playlist in random order.
SHUF DEVICE	device in random order.

To return to normal play mode, select "**↵ OFF**" or "SHUF OFF."

SET UP RADIO CD USB

Adjusting the sound characteristics — BAL/FAD/SUB

You can adjust the balance, fader, and subwoofer volume.

- 1** Press the select button repeatedly until "BAL," "FAD" or "SUB" appears.

The item changes as follows:
LOW*1 → **MID***1 → **HI***1 → **BAL** (left-right) → **FAD** (front-rear) → **SUB** (subwoofer volume)*2 → **AUX***3

*1 When EQ3 is activated.
 *2 When the audio output is set to "SUB." "ATT" is displayed at the lowest setting, and can be adjusted up to 20 steps.
 *3 When AUX source is activated.

- 2** Rotate the volume control dial to adjust the selected item.

After 3 seconds, the setting is complete and the display returns to normal play/reception mode.

SET UP RADIO CD USB

Customizing the equalizer curve — EQ3

"CUSTOM" of EQ3 allows you to make your own equalizer settings.

- 1** Select a source, then press **(EQ3)** repeatedly to select "CUSTOM."

- 2** Press the select button repeatedly until "LOW," "MID" or "HI" appears.

- 3** Rotate the volume control dial to adjust the selected item. The volume level is adjustable in 1 dB steps, from -10 dB to +10 dB.



Repeat steps 2 and 3 to adjust the equalizer curve.

To restore the factory-set equalizer curve, press and hold the select button before the setting is complete.

After 3 seconds, the setting is complete and the display returns to normal play/reception mode.

SET UP RADIO CD USB

Adjusting setup items — SET

- 1** Press and hold the select button. The setup display appears.
- 2** Press the select button repeatedly until the desired item appears.
- 3** Rotate the volume control dial to select the setting (example "ON" or "OFF").
- 4** Press and hold the select button. The setup is complete and the display returns to normal play/reception mode.

Note
 Displayed items will differ, depending on the source and setting.

The following items can be set:
 "●" indicates the default settings.

CLOCK-ADJ (Clock Adjust)
 To set the clock.

CT (Clock Time)
 To set "CT-ON" or "CT-OFF" (●).

BEEP
 To set "BEEP-ON" (●) or "BEEP-OFF."

AUX-A*1 (AUX Audio)
 To turn the AUX source display "AUX-A-ON" (●) or "AUX-A-OFF."

A.OFF (Auto Off)
 To shut off automatically after a desired time when the unit is turned off,
 - "A.OFF-NO" (●), "A.OFF-30S (Seconds)," "A.OFF-30M (Minutes)" or "A.OFF-60M (Minutes)."

SUB/REAR*1
 To switch the audio output.
 - "SUB-OUT" (●): to output to a subwoofer.
 - "REAR-OUT": to output to a power amplifier.

DEMO*1 (Demonstration)
 To set "DEMO-ON" (●) or "DEMO-OFF."

DIM (Dimmer)
 To change the brightness of the display.
 - "DIM-ON": to dim the display.
 - "DIM-OFF" (●): to deactivate the dimmer.

ILM (Illumination)
 To change the illumination color: "ILM-1" (●) or "ILM-2."

A.SCRL (Auto Scroll)
 To scroll long displayed item automatically when the album/track is changed.
 - "A.SCRL-ON" (●): to scroll.
 - "A.SCRL-OFF": to not scroll.

LOCAL (Local Seek Mode)
 - "LOCAL-ON": to only tune into stations with stronger signals.
 - "LOCAL-OFF" (●): to tune normal reception.

MONO*2 (Monaural Mode)
 To improve poor FM reception, select monaural reception mode.
 - "MONO-ON": to hear stereo broadcast in monaural.
 - "MONO-OFF" (●): to hear stereo broadcast in stereo.

REG*2 (Regional)
 To set "REG-ON" (●) or "REG-OFF."

LPF*3 (Low Pass Filter)
 To select the subwoofer cut-off frequency: "LPF OFF" (●), "LPF125Hz" or "LPF 78Hz."

BTM
 To store radio stations automatically.

*1 When the unit is turned off.
 *2 When FM is received.
 *3 When the audio output is set to "SUB."